



# DM50 Series Digital Mailing System (K700 series)



**Operator Guide**  
UK and ROI Version



# Table of Contents

## 1 • Introduction

About Your DM50 Series .....	1-1
About Downloads to Your DM50 Series .....	1-2
Postal Requirements.....	1-3
Safety.....	1-4
Specifications.....	1-6
Equipment .....	1-6
Material .....	1-6
Meter Specifications .....	1-7

## 2 • Getting to Know Your DM50 Series

DM50 Series Digital Postage Meter–Front .....	2-1
Control Panel .....	2-2
DM50 Series Digital Postage Meter–Rear .....	2-4

## 3 • Running Mail

Before You Begin .....	3-1
Checklist .....	3-1
Home Screen .....	3-1
Selecting Postage .....	3-2
Using the Scale with the Internal Rating Module.....	3-3
Weight Hold Mode .....	3-3
Entering Weight Manually with the Internal Rating Module .	3-3
Keying In the Postage Directly (Not available in UK) .....	3-4
Misc Oayment Carrier (UK Only).....	3-4
Parcelforce FrankPay (UK Only) .....	3-4
Selecting an Account to Track Postage .....	3-4
Envelope Messaging.....	3-5
Advancing the Date Print .....	3-6
Checking and Clearing the Batch Count.....	3-7
Checking the Batch Count.....	3-7
Printing a Record of the Batch Count information .....	3-7
Clearing the Batch Count .....	3-7
Printing Mail .....	3-8

# **Table of Contents**

---

## **4 • Printing Options**

Printing Options .....	4-1
Printing the Date and Time Only (no meter stamp) .....	4-1
Printing Envelope Messaging Only (no meter stamp) .....	4-2

## **5 • Adding Postage**

Adding Postage.....	5-1
Connection Using PC Meter Connect™ or Phone?.....	5-1
Connecting Your System Using PC Meter Connect™ .....	5-1
Connecting Your DM50 Series to an Analogue Phone Line....	5-2
Checking the Funds (Postage) in Your DM50 Series .....	5-2
Checking Your Account Balance in the Postage By Phone® System .....	5-3
Adding Postage to Your DM50 Series .....	5-3
Connecting to the Data Centre (Other than for postage).....	5-4
Downloads from the Data Centre to Your DM50 Series .....	5-4

## **6 • System Settings**

Machine Settings .....	6-1
Setting System Time .....	6-1
Setting Display Contrast .....	6-2
Using the Preset Feature .....	6-2
Turning the Preset Feature On or Off .....	6-3
Storing a New Preset.....	6-3
Viewing the Preset.....	6-4
Recalling the Preset .....	6-4
Setting/Disabling the Lock Code.....	6-5
Setting Sleep Mode Activation Time .....	6-6
Activating Sleep Mode Manually.....	6-6
Setting the High Value Warning .....	6-7
Setting the Low Funds Warning.....	6-7
Settings for the Scale.....	6-8
Reset Scale to Zero.....	6-8
Activating/Disabling Weight Hold Mode.....	6-8
Entering the Prefix for Dialling Out to Data Centre .....	6-9
Selecting Tone/Pulse for Dialling Out to Data Centre .....	6-9

# Table of Contents

---

Using the Text Ad Option .....	6-10
What is a Text Ad? .....	6-10
Creating a new Text Ad.....	6-10
Viewing a Text Ad .....	6-11
Edit a Text Ad.....	6-11
Delete a Text Ad .....	6-12
Other Settings .....	6-12

## 7 • Ink Maintenance

Low Ink Warnings.....	7-1
Replacing the Ink Cartridge .....	7-1
Printing Test Pattern.....	7-3
Cleaning Printer Nozzles .....	7-4
Replacing the Print Head.....	7-5
Replacing the Ink Tray .....	7-6

## 8 • Reports

Funds Report .....	8-1
Refill Summary Report.....	8-1
Account Reports .....	8-2
Software Version Report.....	8-3
View Software Versions (not printed).....	8-3

## 9 • Accounting Setup

Optional Departmental Accounting Feature .....	9-1
Turning Accounting Feature ON or Off.....	9-1
Creating an Account.....	9-2
Editing an Existing Account.....	9-3
Viewing Account Totals .....	9-3
Clearing All or Some of the Accounts.....	9-4
Deleting an Account.....	9-5

# **Table of Contents**

---

## **10 • Troubleshooting**

Getting Help .....	10-1
Error Messages.....	10-2
Nothing Displays .....	10-3
Printing is Incomplete, Streaked, or Poor Quality .....	10-3
Display is Difficult to Read .....	10-4
Problems Dialling Out .....	10-4
Accidentally Printing the Wrong Postage.....	10-4

## **11 • Supplies and Options**

How to Order.....	11-1
Supplies .....	11-1
Options.....	11-2

## **Appendix A**

When is Text Entry Used?.....	A-1
How is Text Entry Done?.....	A-1
Account Names, Text Ads.....	A-1
Special Characters .....	A-2

## **Appendix B**

Glossary.....	B-1
---------------	-----

# Section 1

## Introduction

### About Your DM50 Series

Your DM50 Series digital postage meter features include:

- Space-saving, compact footprint
- Easy-to-read display shows system status and prompts you through setup operations
- Automatic date advance
- Keyboard-selectable envelope ads
- Convenient postage-adding via Postage By Phone® meter payment system (requires an analogue phone line or an internet enabled PC and PC Meter Connect™ software)
- Ink jet printer provides clear, crisp imprints
- Scale weighs mail pieces
- Rating feature calculates correct postage
- Optional date and time stamp for use on incoming mail or on sensitive documents
- Optional accounting feature tracks postage costs by department
- Optional user defined text message facility
- Password protection limits access to authorised personnel
- Full report printing capability provides hard-copy records of your postage transactions
- USB communication port

---

**NOTE:** Although this guide describes all the features listed above, your DM50 Series is a configurable system and availability of the features will depend on your model, options purchased and your country requirements. Inclusion in this guide does not guarantee availability of a particular model or feature within your country.

---

# 1 • Introduction

---

## **About Downloads to Your DM50 Series**

Your DM50 Series meter uses the IntelliLink® postage meter system, which allows you to download information directly into your machine. The IntelliLink® postage meter system technology gives you the ability to:

### *Add postage funds conveniently*

You can add funds to your DM50 Series electronically via the Postage by Phone Data Centre (requires an analogue phone line or an internet enabled PC and PC Meter Connect™ software).

### *Download Postal Rate Updates*

The latest postal rates can be purchased and downloaded precisely when you need them.

### *Add Features On Demand*

You can download envelope ads and optional product enhancements such as departmental accounting. Please contact your machine supplier to order.

### *Keep Your DM50 Series Meter Current*

Software download capability means you'll always have the latest version of your DM50 Series meter's operating system.

## Postal Requirements

The meter on your mailing machine is licensed by your Postal Authority and you must follow some basic requirements.

- Mail must have the correct date and postage amount in the meter stamp.
- Always ensure that your meter stamp prints are clear and complete. Poor prints may result in your Postal Authority being unable to offer the service you requested and if the prints are illegible the items may be rejected by your Postal Authority. If in doubt regarding the quality of your meter prints, refer to page 7-4 for further information.
- If you move to another address, you must update the Postal Authority records. Call your local machine supplier for advice.
- The tape sheets for putting postage on larger items must conform to postal specifications. For best performance, obtain tape sheets direct from your machine supplier.
- Postal Inspection (mandatory) - UK Only

An Audit is made of your meter automatically when you connect to the Data Centre, this uploads information to the Postal Authority. The Data Capture Audit takes place every 30 days. However, there is a grace period of 5 days to allow you to connect to the Data Centre.

- Postal Inspection (mandatory) - REPUBLIC OF IRELAND Only

Each time you add postage to the machine, the Data Centre automatically performs a postal inspection as required by the Postal Authority. If the interval between inspections is too long, your machine's display prompt "Inspection Due". Eventually, if an inspection is still not carried out, the display prompts "Inspection Required". You won't be able to use your mailing system until your system is inspected.

# 1 • Introduction

---

## Safety

Follow the normal safety precautions for all office equipment:

- Use only Pitney Bowes approved supplies, in particular aerosol dusters. Improper storage and use of aerosol dusters or flammable aerosol dusters can cause an explosive-like condition that could result in personal injury and/or property damage. Never use aerosol dusters labeled flammable and always read instructions and safety precautions on the duster label.
- To obtain supplies, please contact our Supply Line™ to place orders. Material Safety Data Sheets can be obtained on the web or from our Supply Line™. Refer to the Contact Information List for more information.
- Use the power cord supplied with the machine and plug it into a properly grounded wall outlet located near the machine and easily accessible. Failure to properly ground the machine can result in severe personal injury and/or fire.
- Avoid touching moving parts or materials while the machine is in use. Keep hands, loose clothing, jewellery and long hair away from all moving parts.
- Do not remove covers or defeat safety interlock switches. Covers enclose hazardous parts that should only be accessed by properly trained service personnel. Immediately report to service any damaged or non-functioning components that renders the unit unsafe.
- Place the unit in an accessible location to allow for proper venting of the equipment and to facilitate servicing.
- The power cord wall plug is the primary means of disconnecting the machine from the AC supply.
- Do not use an adapter plug on the line cord or wall outlet.
- Do not remove the ground pin from the line cord.
- Avoid using wall outlets that are controlled by wall switches, or shared with other equipment.
- Do not route the power cord over sharp edges or trap between furniture.
- Ensure there is no strain on the power cord and that it does not become jammed between the equipment, walls or furniture.

- Be certain the area in front of the wall receptacle into which the machine is plugged is free from obstruction.
- Before clearing a stoppage, be sure machine mechanisms come to a stop.
- When removing stalled material, avoid using too much force to protect against minor personal injury and damaging equipment.
- To prevent overheating, do not cover any vent openings.
- Operation of this equipment without periodic maintenance will inhibit optimum operating performance and could cause the equipment to malfunction. Contact your machine supplier for required service schedule.
- Read all instructions before attempting to operate the equipment.
- Use this equipment only for its intended purpose.
- Always follow the specific occupational safety and health standards for your workplace.
- This device is not intended for use in the direct field of view at visual display workplaces. To avoid incommodating reflections at visual display workplaces this device must not be placed in the direct field of view.

# 1 • Introduction

---

## Specifications

### **Equipment**

*Size of Base Model:*

213mm High x 351mm Long x 264mm Deep

*Size of Base Model with Optional Scale:*

231mm High x 351mm Long x 264mm Deep

*Weight:* 3.6kg without scale, 4.0kg with scale

*Power Requirements:* 220-240 VAC, 50/60Hz. 0.25A

*Communications Ports:* 1 USB; 1 RJ-11, 1 Serial

*Operating Temperature:* 14°C to 35°C

*LCD Display:* 2 lines, 20 characters long

*Throughput:* Up to 18 letters per minute

Actual throughput will vary, depending on the material used, graphic printed, machine environment, and the skill of the operator.

*Print Resolution:* 300 x 600 dpi

*Maximum Print Image Area:* 25.2mm x 140mm

*Ink Cartridge Capacity:* 18ml

*Tape Sheets:* self-adhesive type (dual tape sheets)

*Internal Graphic Ad Storage:* up to 15

*Internal Postal Inscription Storage:* up to 15

Availability of inscriptions is based on country requirements.

*Departmental Accounting (optional):* Number of accounts available is based on the amount purchased and model.

### **Material**

*Minimum Size:* 127mm Wide x 89mm Deep

*Thickness:* 0.18mm to 8.0mm

---

**IMPORTANT:** For best results, always make sure your material conforms to our published specifications.

---

## **Meter Specifications**

### **Republic of Ireland Models:**

Maximum Imprint:	€99.99
Maximum Credit Setting:	€9,990.00
Setting Increment:	€10
Reset Type:	Postage by Phone
Piece Count:	Up to 8 digits (nonresettable)

### **UK Models:**

Maximum Imprint:	£99.99
Maximum Credit Setting:	£9,990.00
Setting Increment:	£10
Reset Type:	Postage by Phone
Piece Count:	Up to 8 digits (nonresettable)

All Pitney Bowes postage meters are manufactured in accordance with An Post's and Royal Mail's Franking Machine Standards. This includes ascending register security, which will lock the ascending registers when the first frank takes the most significant digit of the ascending register to 9.



It is certified that the system complies with all applicable Directives of the European Union.

For a formal Declaration of Conformity please contact Compliance Engineering. Contact information is given in the front of this guide or on a separate document supplied with your system.

The system has been designed to work on all Pan-European Analogue Telecommunication Networks.



# Section 2

## Getting to Know Your DM50 Series

### DM50 Series Digital Postage Meter – Front



1. **Control Panel**—allows you to enter and set up information on your meter.
2. **LED**—lights amber when your DM50 Series meter is low on ink (one blink indicates the DM50 Series meter is out of ink).
3. **Scale (optional in some markets)**—allows you to weigh a mail piece so you or the DM50 Series meter, can calculate the correct postage.
4. **Top Cover**—opens to allow replacement of the ink cartridge. See *Section 7 - Ink Maintenance* for instructions.
5. **Mail Deck**—supports your envelope, post card or tape sheet as you insert it for printing.

## 2 • Getting to Know Your DM50 Series

---

### Control Panel

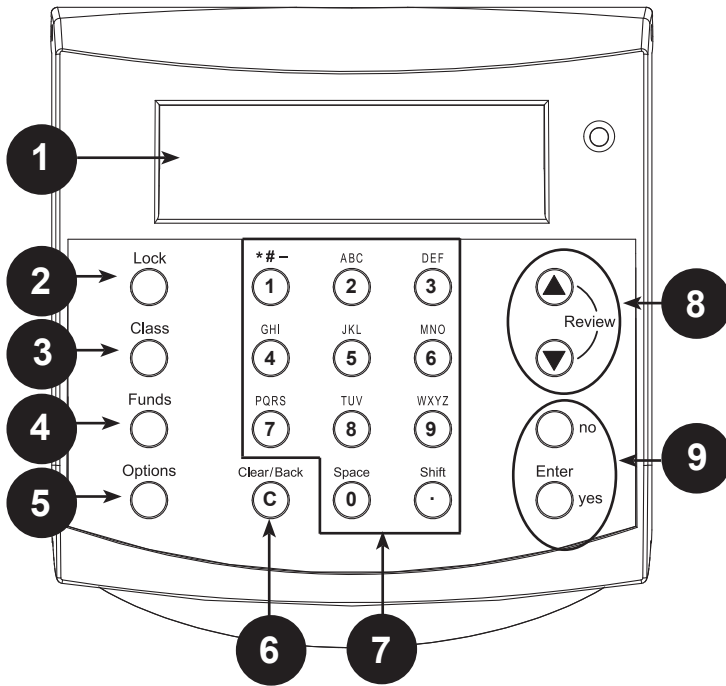

1. **LCD Display**—shows the current status of your DM50 Series meter and prompts you through all setup operations in a two-line LCD.
2. **Lock Key**—prevents unauthorised use of your DM50 Series meter if the lock feature is set up and the DM50 Series meter is in "sleep mode". Entering your four-digit password unlocks (wakes-up) the meter.
3. **Class**—allows you to select class and calculate postage based on the service selected, if you have the optional internal rating system feature. See *Section 3 - Running Mail* for details.
4. **Funds**—allows you to check and add postage funds to your DM50 Series meter. See *Section 5 - Adding Postage* for details.
5. **Options**—allows you access to the setup options of the DM50 Series meter, such as date, time, etc. See *Section 6 - Machine Settings* for details.

## 2 • Getting to Know Your DM50 Series

---

6. **Clear/Back**—allows you to clear or cancel an entry or return to the previous screen/level of menu.
7. **Alpha/Numeric Keypad**—allows you to type in numbers and letters for account names, postage values, and other information. See *Appendix A - Entering Text* for more information.
8. **Review Keys**—allows you to scroll through choices in the LCD display or review the current settings.
9. **Enter/Yes and No Keys**—allow you to confirm an operation or answer “Yes” or “No” to a prompt. The **Enter/yes** key also functions as the Enter key for data entry.

## 2 • Getting to Know Your DM50 Series

---

### DM50 Series Digital Postage Meter – Rear

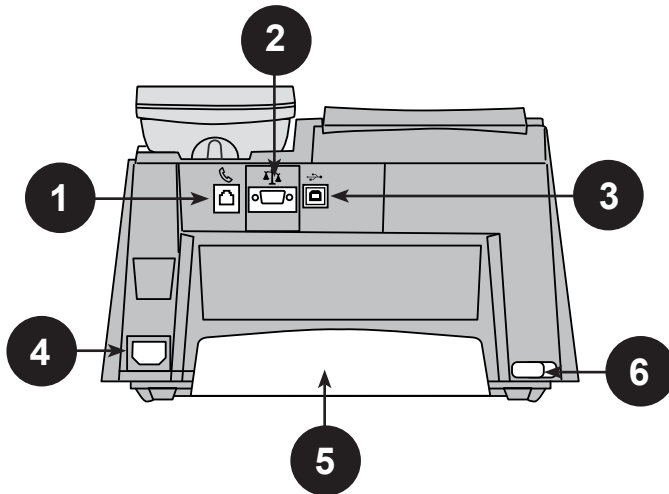

1. **Phone Connector**—allows you to connect to an analogue phone line, such as one that a Fax machine uses. The connector accepts a standard phone plug (supplied). When your DM50 Series meter is connected to an analogue phone line, you can add postage by pressing **Funds** and following the prompts. See *Section 5 - Adding Postage* for details.
2. **Serial Port**—allows you to connect the optional scale to weigh your mail piece.
3. **USB Port**—allows you to connect a USB cable and connect to IntelliLink® via PC Meter Connect™ Software and an internet enabled PC. See *Section 5 - Adding Postage*.
4. **Power Receptacle**—connects to AC power cord (supplied).
5. **Ink Tray**—holds excess ink that results from the printing process. See *Section 7 - Ink Maintenance* for further details.
6. **Ink Tray Lever**—by sliding lever, it allows you to remove the ink tray.

# Section 3

## Running Mail

### Before You Begin

Before you run mail on your system, review the Checklist, Home Screen, and Applying Postage sections below and on the next page.

### Checklist

- Make sure your mailing system is plugged into a properly grounded power receptacle. Always follow the safety precautions in *Section 1, Introduction*.
- If you plan on printing tape sheets, make sure you've got an adequate supply. See *Section 11, Supplies and Options* for ordering tape sheets.
- Check that you have enough postage for your mail run. Press the **Funds** key to view your current balance (Unused).

### Home Screen

When you power up your system, the Home screen appears on the operating display. If your system has been set up to require a lock code or password, you are prompted to enter it.

A typical Home screen is show below (your screen will vary slightly):

£0.29	0 g
RM 1st	07.OCT

Pressing the **Review** ▲ ▼ keys when the Home screen is displayed will cycle through the printing options such as Account, Envelope Messaging, etc. that you currently have selected.

## 3 • Running Mail

---

### Selecting Postage

There are several ways you can select postage using your mailing system:

- Place the mail piece on the optional scale and have the system calculate the weight and then postage amount using the system's internal rating feature.
- Enter the weight of the mail piece manually and have the system calculate the postage amount using the system's internal rating feature (if you have the optional rating feature).
- Key in the postage directly from the keyboard when you already know the amount (**not available in the UK**).

Each method is described in its own section that follows.

---

#### NOTES:

- For applying postage, the DM50 Series does not have to be connected to a phone line. However, when you need to add funds to your DM50 Series, it must be connected to an analogue phone line (see *Section 5 - Adding Postage/Connecting to Data Centre* for more information).
  - The meter automatically advances the date at midnight.
  - If you need to choose a country when selecting a class, you can either use the **Review ▲ ▼** keys to scroll through the alphabetical country list, or you can type the initial letter of the country name to jump straight to that letter in the listing.
- 

### Using the Scale with the Internal Rating Module

Use this procedure when you use the scale to automatically weigh and calculate the correct postage value.

1. Place the mail piece onto the integrated scale. The weight of the mail piece will appear on the display.
2. Press the **Class** key, and use either the numeric keys or the scroll keys to select the Carrier/Class required. Press the **Enter** key to confirm this and any further selections. Follow the prompts for the options and/or services available for the postal class required.
3. The display shows the final postage amount together with the selected class.

### *Weight Hold Mode*

Use this mode when the size of the mail piece covers the display screen. The DM50 Series holds the weight in memory until you select a class and finish the rating process. When using this mode:

- "WH" displays when the weight is in memory.
- The weight remains for 10 seconds after the piece is removed.
- To extend the time, press **Enter/yes**.
- To clear the weight before the 10 seconds finish, press **Clear/Back**.

Instructions for activating the mode are given in *Section 6 - Machine Settings*.

### *Entering Weight Manually with the Internal Rating Module*

This feature may be an added cost option on your model or may not be available.

Use this procedure when you already know the weight of a mail piece and you are not using an integrated scale, or the mail piece exceeds the weighing capacity of the scale.

1. Press **Options**.
2. Use the **Review ▲ ▼** keys to scroll to "Type in weight?", then press **Enter/yes** to confirm.
3. Key in the weight in grammes then press **Enter/yes**.
4. If no class has been selected, the DM50 Series will automatically request that you choose a class now. Select the desired class and then follow the prompts for the options and/or services available for this postal class.

If a class was already selected, the DM50 Series will retain the class selection.

5. The display shows the final postage amount and class chosen.

## 3 • Running Mail

---

### **Keying In the Postage Directly (Not available in the UK)**

1. From the Home screen, enter the postage using the numeric keys. There is *no need* to enter the decimal point.
2. Press **Enter/yes** to confirm the amount.

### **Misc Payment Carrier (UK Only)**

Occasionally, your postal authority may need an additional payment (underpayment, etc). to produce a Frank for payment, press **Class**, then select the "Misc Payment" Carrier, followed by the "Misc Payment" class. You can now enter the value of underpayment required. Press **Enter** to confirm the amount and take a Frank in the normal way.

### **Parcelforce FrankPay (UK Only)**

If you wish to use your Franking machine to process Parcelforce Frankpay transactions, press **Class**, then select the "Royal Mail" carrier. Scroll down and select "Parcelforce". Select the "Frankpay" service and the "Enter Amount" option. Key in the amount in £ and press the **Enter/Yes** key to confirm, Then process a Frank on a Tape Sheet.

### **Selecting an Account to Track Postage**

You can select an account to track postage if the optional departmental accounting feature is available on your machine and is turned on. Departmental accounting may not be available on some models. See *Section 9, Departmental Accounting*, for information on setting up this feature.

1. From the Home screen, press the down **Review ▼** key until "Account:" displays, then press **Enter/yes**.
2. The "Select Account:" screen displays. To select an account, either:
  - A. Press the **Review ▲ ▼** keys until you see the account required, then press **Enter/yes**. Or...
  - B. Key in the first digit of the account number if you know it and press **Enter/yes**.
4. If a password has been assigned to this account, you will be prompted to enter it now. Key in the 4-digit password if necessary then press **Enter/yes**.
5. You will now return to the Home screen with the new account selected.

### Envelope Messaging

When printing mail, you can also print Envelope Messaging alongside the postal frank. Envelope Messaging can consist of a Graphic Ad or a Text Ad.

---

#### NOTES:

- Graphic Ads are available on all models. Some are preinstalled on your system and additional custom Graphic Ads can be ordered from Pitney Bowes.
  - Text Ads are an option only available on certain models.
  - Graphic Ads and Text Ads print in the same location and so cannot be printed together on a postal impression.
  - See *Section 6, Machine Settings* for more information on creating Text Ads.
  - See *Section 11, Supplies and Options* for more information on Graphic Ads and Text Ads option availability.
- 

1. From the Home screen, press the down **Review ▼** key and select “Ad:” to select a Graphic Ad or Text Ad, as required. Press **Enter/yes**.
2. Press the **Review ▲ ▼** keys until you see the item required, then press **Enter/yes**.
3. You will now return to the Home screen with the new item selected for printing.

## 3 • Running Mail

---

### Advancing the Date Print

The DM50 Series will automatically advance the date printed at midnight.

However, you may want to advance the date printed if it is after normal business hours and you want to prepare outgoing mail for a future business day's mailing.

---

**NOTE:** Please keep in mind the following when using this feature:

- Changing the printed date does not change the DM50 Series meter's internally held date.
  - You can always return the printed date to the current date.
  - You cannot change the printed date to a date earlier than the DM50 Series meter's internally held date (in an effort to "backdate" the mail).
  - The number of days you can advance the print is limited to 30 days. This limit is set by Royal Mail and An Post.
- 

1. Press **Options**.
2. Press the **Review ▲ ▼** keys to scroll to "Change date and time settings?", then press **Enter/yes**.
3. Use the **Review ▲ ▼** keys to scroll (if necessary) to "Change printed date?", then press **Enter/yes**.
4. Use the **Review ▲ ▼** keys to select a date. When the date required is displayed, press **Enter/yes**. A message confirms your choice and the Home screen displays showing the new date to be printed.

---

**NOTE:** When you want to restore the date print to today's date, at Step 4 above, then use the **Review ▲ ▼** keys to return to today's date and finally press **Enter/yes** to confirm the change.

---

### Checking and Clearing the Batch Count

You can view the accumulated postage value and piece count information from the batch register and print this for your records. You can also clear or reset the batch count to zero before starting the next batch of printing.

#### ***Checking the Batch Count***

1. Press **Funds**.
2. Press the **Review ▲ ▼** keys to scroll until the display shows the batch information.
3. Press **Clear/Back** to return to the Home screen.

#### ***Printing a Record of the Batch Count information***

The DM50 Series can print a Funds Report containing the batch information. Refer to *Section 8, Reports* for more information.

#### ***Clearing the Batch Count***

---



**CAUTION:** Make sure you really want to clear the batch register; once you do, you can't restore the data.

---

1. Press **Funds**.
2. Press the **Review ▲ ▼** keys to scroll and select "Reset batch value and pieces?", then press **Enter/yes**.
3. At the prompt asking for confirmation to clear, press **Enter/yes**. batch value and batch piece registers return to zero.
4. Press **Clear/Back** to return to the Home screen.

## 3 • Running Mail

---

### Printing Mail

To apply postage to large items of mail and parcels that can't be run through the machine, use the optional tape sheets. Feed the tape sheets into the machine the same way you would feed an envelope. Apply the postage tape sheets to the mail piece or parcel in the proper location.

1. Select the postage options required, (account, Envelope Messaging, etc.) as described previously in this section.
2. Keeping the envelope or tape sheet against the registration wall, slide it into the DM50 Series. The system prints the digital meter impression and indicates when to remove the mail piece.



**Important:** See note on following page regarding print quality and ink requirements.



**IMPORTANT:** Always ensure that your prints are clear and complete. Poor prints may be rejected by your Postal Authority. If you notice missing lines in the print as shown in the illustration, clean the printer nozzles as described on page 7-4 of this guide.



The indicia above is a black and white representation of the approved indicia.

For customers who use the standard Royal Mail product suite, only Red non-fluorescent approved ink should be used in the machine. Customers in the Republic of Ireland should only use Red non-fluorescent ink approved by An Post in the machine.



# Section 4

## Printing Options

### Printing Options

In addition to printing postage, your DM50 Series can print a Date and Time stamp or Envelope Messaging only onto incoming mail.

---

**NOTE:** These options may be an added cost option on your model or may not be available.

---

#### ***Printing Date and Time Only (no meter stamp)***

You may want to use this feature to time-stamp incoming mail or sensitive documents.

1. Press **Options**.
2. Use the **Review ▲ ▼** keys to scroll to "Change meter stamp type?", then press **Enter/yes** to confirm.
3. Use the **Review ▲ ▼** keys to scroll to "Print date and time only?", then press **Enter/yes** to confirm. The Home screen displays the date and time which will print and the 'Date/Time Only' reminder.
4. Keeping the envelope against the registration wall, slide it into the DM50 Series. The system prints the date and time stamp and indicates when to remove the mail piece.

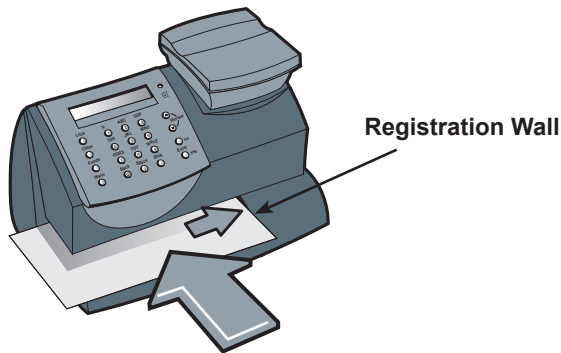

---

**NOTE:** When you want to revert to normal printing, press **Clear/Back** and answer **Enter/yes** at the "Return to Printing Postage" prompt.

---

## 4 • Printing Options

---

### **Printing Envelope Messaging Only (no meter stamp)**

You may want to use this feature to add your company's message to incoming mail.

1. Press **Options**.
2. Use the **Review ▲ ▼** keys to scroll to "Change meter stamp type?", then press **Enter/yes** to confirm.
3. Use the **Review ▲ ▼** keys to scroll to "Print ad only?", then press **Enter/yes** to confirm. If you have already selected Envelope Messaging for your normal meter stamp, that is used; otherwise, you are prompted to choose. When completed, the Home screen displays the name of the graphic or text ad selected and the 'ad only' reminder.
4. Keeping the envelope against the registration wall, slide it into the DM50 Series. The system prints the Envelope Messaging and indicates when to remove the mail piece.

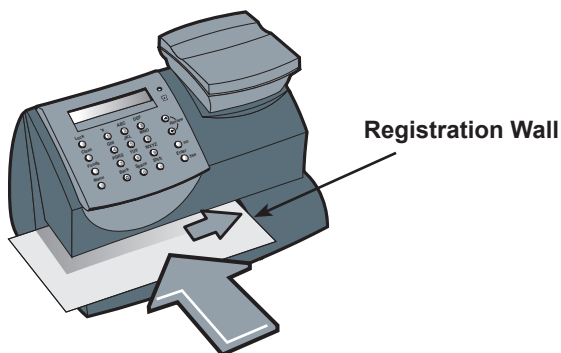

---

**NOTE:** When you want to revert to normal printing, press **Clear/Back** and answer **Enter/yes** at the "Return to Printing Postage" prompt.

---

# Section 5

## *Adding Postage/Connecting to Data Centre*

### **Adding Postage**

Adding postage funds to your system is fast, easy and convenient. It can be carried out using the internal modem connected to an analogue phone line or using a PC connected to the internet with PC Meter Connect™ software installed.

### **Connection Using PC Meter Connect™ or Phone?**

Your Mailing System can connect to Pitney Bowes systems via your PC's existing internet connection using PC Meter Connect™ software instead of an analogue telephone line.

**NOTE:** PC Meter Connect™ software may not be available in all markets.

To do this, you will need to install PC Meter Connect™ Software onto your internet enabled PC.

You will obtain much quicker connection speeds when your Mailing System connects to Pitney Bowes for services such as; Postage by Phone®, System Updates, Features On Demand, Electronic Postal Inspection and Data Centre Information Exchange.

In addition, because your Mailing System will be connected via your PC, you'll no longer need a dedicated analogue phone line for it. This means that if you're paying line rental for a single analogue phone line solely for the Mailing System you will no longer need it.

### **Connecting Your System Using PC Meter Connect**

As you install PC Meter Connect™ software, you will be prompted to connect your mailing system to your PC using a USB cable. PC Meter Connect™ will then test your internet connection and take you through the software installation process.

Once installed there will be a PC Meter Connect™ icon in your PC's system tray. Clicking this icon will give you access to PC Meter Connect's internet settings and language selection (if available in your country).

## 5 • Adding Postage/Connecting to Data Centre

---

### Connecting Your DM50 Series to an Analogue Phone Line

Plug the telephone cord (supplied) into the connector on the back of the DM50 Series meter (see figure at right).

Plug the other end into your telephone wall socket. A two way adapter (splitter) is supplied if you need to share this socket with your fax machine, etc.

Remember to use an analogue phone line. The following are normally analogue phone lines:

- Fax lines.
- Lines used by modems or credit card readers.
- Residential phone lines.



Plug phone line in here

### Checking Funds (Postage) Available in your DM50 Series

1. Press **Funds**. The amount left (Unused) in the DM50 Series displays.
2. Press the **Review ▲ ▼** keys for additional information on batch values.
4. Press **Clear/Back** to return to the Home screen.

---

**NOTE:** You can print a report of the funds available. See "Funds Report" in *Section 8, Reports*.

---

## **5 • Adding Postage/Connecting to Data Centre**

### **Checking Your Account Balance in the Postage By Phone® System**

To check your Postage By Phone® system account balance:

1. Connect your DM50 Series to an analogue phone line or via PC Meter Connect™.
2. Press **Funds**. The amount left (Unused) in the DM50 Series displays.
3. Use the **Review ▲ ▼** keys to scroll to "Check balance available?", then press **Enter/yes**.
4. The DM50 Series connects to the Data Centre. When connected, the amount in your Postage By Phone® (PbP) account displays.
5. Press **Clear/Back**. The system asks if you wish to refill postage.
6. Press **Clear/Back** to return to the Home screen, or **Enter/yes** if you would like to add postage immediately.

### **Adding Postage to Your DM50 Series**

You can add postage to your DM50 Series as long as you have enough funds in your Postage By Phone® account.

1. Connect your DM50 Series meter to an analogue phone line or via PC Meter Connect™.
2. Press **Funds**. The amount left (Unused) in the DM50 Series displays.
3. Use the **Review ▲ ▼** keys to scroll to "Refill postage?", then press **Enter/yes**.
4. Key in the refill amount, then press **Enter/yes**. The amount of postage you add must be in increments of £10 in the UK and €10 in the Republic of Ireland.
5. At the refill amount confirmation prompt, press **Enter/yes**.
6. The DM50 Series connects to the Data Centre. Various screens display, letting you know the status of the process. When complete, the refill successful message displays.
7. Press **Enter/yes**. You will be asked if you want to print a receipt.  
EITHER      Insert an envelope/tape sheet into the DM50 Series to print a receipt.  
  
OR             Simply press **no** to return to the Home Screen without printing a receipt.

## ***5 • Adding Postage/Connecting to Data Centre***

---

### **Connecting to the Data Centre (Other than for postage)**

You can connect to the Data Centre to download a feature you ordered, comply with Postal Authority inspection regulations, etc.

1. Connect your DM50 Series meter to an analogue phone line or via PC Meter Connect™.
2. Press **Options**.
3. Use the **Review ▲ ▼** keys to scroll to "Connect to Pitney Bowes?", then press **Enter/yes**.
4. The DM50 Series connects to the Data Centre. When connected, you are told of any downloads available.
5. Follow the prompts to start the download(s) as necessary. Various screens display, letting you know the status of the process.
6. When finished, press **Enter/yes** to return to the Home screen.

### **Downloads from the Data Centre to Your DM50 Series**

When you connect to the Data Centre (using an analogue phone line) to add postage or perform other transactions, the Data Centre may perform the following:

- Download required software updates to your machine.
- Download advertisements you ordered.
- Perform a remote inspection of your machine as required by the Postal Authority.
- Download new postal rates.

Generally speaking, downloads are considered either mandatory (you must do them at the time you are prompted to on the screen), or non-mandatory (you may decide to download at a later time). However, even non-mandatory downloads can become mandatory if you wait too long to do the download.

Once a download is finished, you will either be prompted to select "Restart Now" to restart the machine or select "Continue" to return you to the screen that you started from, depending on the type of download performed.

A description of the type of downloads that can occur in your machine are presented on the following pages.

## ***5 • Adding Postage/Connecting to Data Centre***

---

### *System Update*

If there has been a feature enhancement or other non-essential update to the software that runs your machine, you will be notified that a system update is available.

### *Ads*

If there are new ads that you ordered available, you will be notified that you can perform a download to obtain these.

### *Software Update (mandatory)*

If there has been an important update to the software that runs your machine, you will be notified that a required update is necessary.

### *Postal Code Update (mandatory)*

If the Postal Code/Town Circle on record at the Data Centre does not match the Postal Code/Town Circle of your mailing system, the correct information will be downloaded into your machine. (When you tell us that your system is moving to a new location, your record in the Data Centre will be updated with the new Postal Code/Town Circle. Your system is updated when a connection is made to the Data Centre.)

### *Postal Inspection (mandatory)*

In the UK, an audit is made of your meter. This uploads information to the Postal Authority. The Data Capture audit takes place every 30 days. However, there is a grace period of 5 days to allow you to connect to the Data Centre.

In the Republic of Ireland, each time you add postage to the machine, the Data Centre automatically performs a postal inspection as required by the Postal Authority. If the interval between inspections is more than 60 days, your machine's display prompts "Inspection Due." If the interval between inspections is more than 90 days, the display prompts "Inspection Required." You won't be able to use your mailing system until your system is inspected.

To satisfy the inspection requirement, simply:

- Add postage (see *Adding Postage* earlier in chapter for procedure).
- Connect to the Data Centre as described in the *Connecting to the Data Centre (other than for postage)* later in this chapter.

When an inspection is performed, an "Inspection Complete" screen displays upon completion. The display also notifies you of the date the next inspection is due.

## ***5 • Adding Postage/Connecting to Data Centre***

---

### *Postal Rate Update (mandatory)*

Postal rates change periodically as defined by your Postal Authority. If new rates are available, you can download them quickly and easily directly from the Data Centre.

The new rates are normally available for download at least 7 days before the effective date. If you connect to the Data Centre and there is time before the effective date, you have a choice whether to download the new rates or not. Once the effective date has been reached (or passed), however, you will have to download the new rates.

The screens on your machine will give you information regarding the status of the rate update and the choices available to you.

If the rate for a normal letter has changed and is effective immediately, a screen displays showing the present preset postage and asks you if you want to reset the normal preset postage. Press **Yes/Enter**. A screen displays for you to enter the new normal rate.

When a rate change update takes place it may also affect other presets you have set in your mailing machine. You should check all your presets to insure that they conform to the new rates. See *Chapter 6, Machine Settings* for instructions on changing preset values.

The display tells you when a rate change update is complete. It also tells you if the update is immediate or takes effect at a later date by listing the new date.

# Section 6

## Machine Settings

### Machine Settings

Machine settings allow you to customise your DM50 Series for the way you run your mail and add security to those features that are sensitive to your organisation. These settings include:

- Setting system time
- Setting display contrast
- Using the preset feature
- Setting/disabling lock code
- Setting sleep mode activation time
- Activating sleep mode manually
- Setting a high value warning
- Setting a low funds warning
- Settings for the scale (optional in some countries)
- Entering the prefix for dialling out to the data centre
- Selecting tone/pulse for dialling out to the data centre
- Using the Text Ad option
- Other settings

### Setting System Time

Use this setting to adjust the system's internal clock. It allows you to correct for minor clock 'drift' or for Daylight Savings/Summer Time.

1. Press **Options**.
2. Use the **Review ▲ ▼** keys to scroll to "Change date and time settings?", then press **Enter/yes** to confirm.
3. Use the **Review ▲ ▼** keys to scroll to "Change time?", then press **Enter/yes** to confirm.
4. Use the **Review ▲ ▼** keys to set the time in 24 hour format. When done, press **Enter/yes** to confirm.

---

#### NOTES:

You cannot change the system time by an amount that would cause a previous day's date to print.

Changing the date is covered on page 3-6 of this guide.

---

## 6 • Machine Settings

---

### Setting Display Contrast

You can adjust the LCD display contrast if necessary.

1. Press **Options**.
2. Use the **Review ▲ ▼** keys to scroll to "Change set up", then press **Enter/yes** to confirm.
3. Use the **Review ▲ ▼** keys to scroll to "Change display contrast?", then press **Enter/yes** to confirm.
4. Select the contrast you want using the numeric keypad and press **Enter/yes**.
5. At the "Stay in Setup?" prompt, reply **yes** or **no** as required.

### Using the Preset Feature

The preset feature allows you to save pre-defined values such as postage, class, weight, Envelope Messaging, etc., within your DM50 Series that you can call up when necessary.

You don't have to program the values that go into the preset in the traditional sense. Instead, the system takes a "snapshot" of the current values on your machine when you define the preset. For example, if the machine is set up to print Envelope Messaging, no class is selected, and a postage amount is already on the screen, these are the conditions that will be recorded by your DM50 Series when you define the preset feature.

If you need to change the values of the preset, just change the machine condition by entering the appropriate settings. The new settings will be recorded when you run the "Storing a New Preset" selection from the menu.

---

#### NOTES:

- If you have stored a preset, the DM50 Series reverts to the preset values when it is first turned on or when it "wakes up" after sleep mode
- Preset postage values are subject to the high value warning (this feature helps prevent you from accidentally printing a postage value that's more than you need; see "Setting the High Value Warning" later in this chapter).
- When a postage rate change is announced, always check the postage value assigned to the preset to make sure it complies with the new rates.

### **Turning the Preset Feature On or Off**

1. Press **Options**.
2. Use the **Review ▲ ▼** keys to scroll to "Change Setup?", then press **Enter/yes** to confirm.
3. Use the **Review ▲ ▼** keys to scroll to "Use preset setup?", then press **Enter/yes** to confirm.

*Turning ON Preset* - Press **Enter/yes** at "Turn preset ON?" prompt. A message confirms your choice. You may view the preset values if you wish, using the **Review ▲ ▼** keys. When finished, press **Clear/Back** repeatedly until you return to the Home screen.

*Turning OFF Preset* - Use the **Review ▲ ▼** keys to scroll to "Turn preset Off?", then press **Enter/yes** to confirm. A message confirms your choice. Press **No** to return to the Home screen.

3. If you have turned on the preset feature, the Home screen reflects the preset settings. If you have turned off the preset feature, the normal Home screen displays.

### **Storing a New Preset**

1. Establish the proper settings on your DM50 Series meter that you want the preset to contain. Depending on the class and weight that is currently displayed on your machine and the options you have purchased, you may be able to store postage, class, weight, date, Envelope Messaging, and inscription.
2. Press **Options**.
3. Use the **Review ▲ ▼** keys to scroll to "Change Setup?", then press **Enter/yes** to confirm.
4. Use the **Review ▲ ▼** keys to scroll to "Use preset setup?", then press **Enter/yes** to confirm.
5. Use the **Review ▲ ▼** keys to scroll to "Store new preset?", then press **Enter/yes** to confirm. You can choose whether to review the settings of the new preset before you store it.

*Yes to Review Settings* - Scroll to view the preset settings of class, account, etc.

*No to Review Settings* - Skips the review.

6. When prompted, press **Yes** to confirm storing of the new preset. A message confirms the new preset has been stored.
7. When finished, follow prompts to return to the Home screen.

## 6 • Machine Settings

---

### ***Viewing the Preset***

1. Press **Options**.
2. Use the **Review ▲ ▼** keys to scroll to "Change Setup?", then press **Enter/yes** to confirm.
3. Use the **Review ▲ ▼** keys to scroll to "Use preset setup?", then press **Enter/yes** to confirm.
4. Use the **Review ▲ ▼** keys to scroll to "View stored preset?", then press **Enter/yes** to confirm.
5. Scroll through the preset values of class, postage amount, account, etc.
6. When finished, press **Clear/Back** repeatedly to return to the Home screen.

### ***Recalling the Preset***

You can call up the preset values at any time to use on your mail with this simple procedure.

1. Press **Options**.
2. Use the **Review ▲ ▼** keys to scroll to "Recall Preset?", then press **Enter/yes** to confirm. You return to the Home screen with the preset values displayed.

### Setting/Disabling the Lock Code

The lock code prevents unauthorised access to your DM50 Series after it has been powered up and/or has entered sleep mode.

1. Press **Options**.
2. Use the **Review ▲ ▼** keys to scroll to "Change Setup", then press **Enter/yes** to confirm.
3. Use the **Review ▲ ▼** keys to scroll to "Use lock code setup?", then press **Enter/yes** to confirm.
4. Follow the prompts to:
  - Change or enter the 4 digit lock code.
  - Set/Turn Off the lock code feature (used when powering-up).
  - Activate/disable the lock code feature during "sleep" mode.Messages display confirming your choices.
5. When finished, follow prompts to return to the Home screen.

#### **IMPORTANT INFORMATION**

Your DM50 Series contains postal funds and if you opt to use the 4-digit Lock Code to secure the funds, it is important that you do not allow your Lock Code to be compromised if the machine is used in an open area. If you believe your Lock Code has been compromised, it should be changed immediately. Alternatively, you may wish to consider locking the machine in a secure area.

## 6 • Machine Settings

---

### Setting Sleep Mode Activation Time

You can set the amount of time the DM50 Series meter waits until entering "sleep mode".

When the DM50 Series meter is in sleep mode, the display is blank (except for the time in the lower right corner of the display) and you can't process mail. You wake up the DM50 Series meter by pressing any button on the control panel or by placing an item on the scale.

1. Press **Options**.
2. Use the **Review ▲ ▼** keys to scroll to "Change Setup", then press **Enter/yes** to confirm.
3. Use the **Review ▲ ▼** keys to scroll to "Change sleep timeout?", then press **Enter/yes** to confirm.
4. Key in the desired amount of time (in minutes, from 1 - 20) the DM50 Series meter should be idle before the sleep mode activates, then press **Enter/yes** to confirm. A message displays confirming your choices.
5. Press **Clear/Back** repeatedly to return to the Home screen.

### Activating Sleep Mode Manually

You can set put the DM50 Series meter into "sleep mode" at any time.

When the DM50 Series meter is in sleep mode, the display is blank (except for the time in the lower right corner of the display) and you can't process mail. You wake up the DM50 Series meter by pressing any button on the control panel or by placing an item on the scale.

1. Press **Lock**.
2. At the prompt to set system to sleep mode, press **Enter/yes**. The machine enters sleep mode.

---

**NOTE:** If you have enabled a lock code (see earlier topic), you will be prompted to enter the lock code to wake up the meter.

---

### Setting the High Value Warning

The DM50 Series will warn you when you manually key in a postage value that is higher than a maximum amount that you specify. This feature helps prevent you from accidentally printing a postage value that's more than you need.

---

**NOTE:** This warning does not function for postage amounts determined by the internal rating feature.

---

1. Press **Options**.
2. Use the **Review ▲ ▼** keys to scroll to "Change Setup", then press **Enter/yes** to confirm.
3. Use the **Review ▲ ▼** keys to scroll to "Change high value warning?", then press **Enter/yes** to confirm.
4. Key in the amount, then press **Enter/yes** to confirm. A confirming message displays.
5. When finished, follow prompts to return to the Home screen.

### Setting the Low Funds Warning

The DM50 Series will warn you when your postage (funds) unused in the machine reaches an amount you specify. This warning acts as a reminder for you to add more postage to your DM50 Series (by connecting to the Data Centre and downloading funds).

1. Press **Options**.
2. Use the **Review ▲ ▼** keys to scroll to "Change Setup", then press **Enter/yes** to confirm.
3. Use the **Review ▲ ▼** keys to scroll to "Change low funds warning?", then press **Enter/yes** to confirm.
4. Key in the amount, then press **Enter/yes** to confirm. A confirming message displays.
5. When finished, follow prompts to return to the Home screen.

## 6 • Machine Settings

---

### Settings for the Scale

The settings described below affect the use of your scale.

#### ***Reset Scale to Zero***

Use this setting to reset the scale to zero if any weight other than 0g appears on the display with the scale platform empty.

1. Press **Options**.
2. Use the **Review ▲ ▼** keys to scroll to "Reset the scale to zero?", then press **Enter/yes** to confirm. The weight on the display returns to 0g.

#### ***Activating/Disabling Weight Hold Mode***

The Weight Hold mode is available in some countries only (see page 3-3 for details of this mode). It can be turned on or off as follows:

1. Press **Options**.
2. Use the **Review ▲ ▼** keys to scroll to "Change Setup", then press **Enter/yes** to confirm.
3. Use the **Review ▲ ▼** keys to scroll to "Change weight hold setup?", then press **Enter/yes** to confirm.
4. Follow the prompts to turn the feature ON or OFF.
5. When finished, follow prompts to return to the Home screen.

### Entering the Prefix for Dialling Out to the Data Centre

You can tell the DM50 Series if you need to dial a prefix number (like 9) to get an outside line when dialling out to the Data Centre.

1. Press **Options**.
2. Use the **Review ▲ ▼** keys to scroll to "Change Setup?", then press **Enter/yes** to confirm.
3. Use the **Review ▲ ▼** keys to scroll to "Change communication settings?", then press **Enter/yes** to confirm.
4. Use the **Review ▲ ▼** keys to scroll to "Change outside line number (prefix)?", then press **Enter/yes** to confirm.
5. Key in the outside line (prefix). A confirming message displays.
6. When finished, follow prompts to return to the Home screen.

### Selecting Tone/Pulse for Dialling Out to the Data Centre

You can tell the DM50 Series if your exchange/telephone system uses tone or pulse type dialling. The vast majority of telephone systems now use tone dialling.

1. Press **Options**.
2. Use the **Review ▲ ▼** keys to scroll to "Change Setup?", then press **Enter/yes** to confirm.
3. Use the **Review ▲ ▼** keys to scroll to "Change communication settings?", then press **Enter/yes** to confirm.
4. Use the **Review ▲ ▼** keys to scroll to "Change dial method?", then press **Enter/yes** to confirm.
5. Use the **Review ▲ ▼** keys to select the dialling method (tone or pulse), then press **Enter/yes** to confirm. A confirming message displays.
6. When finished, follow prompts to return to the Home screen.

## 6 • Machine Settings

---

### Using the Text Ad option

Text Ads are only available as an option on certain models of DM50 Series.

#### ***What is a Text Ad?***

A Text Ad is a user defined message typed in via the machine's keyboard that can be printed on your digital meter impression.

#### ***Creating a new Text Ad***

1. Press **Options**.
2. Use the **Review ▲ ▼** keys to scroll to "Change Setup?", then press **Enter/yes** to confirm.
3. Use the **Review ▲ ▼** keys to scroll to "Use text Ad setup?", then press **Enter/yes** to confirm.
4. Use the **Review ▲ ▼** keys to scroll to "Create Text Ad?", then press **Enter/yes** to confirm.
5. Follow the on screen prompts to enter the Text Ad name and each line of text. Each line can be up to 20 alpha/numeric characters long. To access alpha characters, repeatedly press the appropriate number key until the desired character displays (for more information see *Appendix A How To Enter Text*).
6. When the Text Ad is finished, select "Create another?" or press **No** if you are finished and the follow the prompts to return to the Home screen.

#### **IMPORTANT INFORMATION**

In accordance with Postal and Advertising Standards requirements the Envelope Messaging (Ad-slogan) and Text must not be obscene, defamatory of any person or group, or deceptive, nor may it advocate unlawful action. The Envelope Messaging (Ad-slogan) must not emulate any form of valid indicia or payment for postage.

### ***Viewing a Text Ad***

1. Press **Options**.
2. Use the **Review ▲ ▼** keys to scroll to "Change Setup?", then press **Enter/yes** to confirm.
3. Use the **Review ▲ ▼** keys to scroll to "Use text Ad setup?", then press **Enter/yes** to confirm.
4. Use the **Review ▲ ▼** keys to scroll to "View Text Ad?", then press **Enter/yes** to confirm.
5. Use the **Review ▲ ▼** keys to select the Text Ad name you want to view. It will be displayed on the screen.
6. Use the **Review ▲ ▼** keys to view each line of the Text Ad.
7. Press **Clear/Back** repeatedly to return to the Home screen.

### ***Edit a Text Ad***

1. Press **Options**.
2. Use the **Review ▲ ▼** keys to scroll to "Change Setup?", then press **Enter/yes** to confirm.
3. Use the **Review ▲ ▼** keys to scroll to "Use text Ad setup?", then press **Enter/yes** to confirm.
4. Use the **Review ▲ ▼** keys to scroll to "Edit Text Ad?", then press **Enter/yes** to confirm.
5. Use the **Review ▲ ▼** keys to scroll to the Text Ad you want to edit, then press **Enter/yes** to confirm. The name of the Text Ad will be displayed.
6. You can edit the name and/or text by using the **Clear/Back** key to delete existing text, the alpha/numeric keys to amend the text and **Enter/yes** to confirm at the end of each line.
7. Repeat this process until you reach the end of the message, at which time the display will show "Text Ad modified". You can now chose to edit another Text Ad, or press **No** and follow the screen prompts to return to the Home screen.

#### **IMPORTANT INFORMATION**

In accordance with Postal and Advertising Standards requirements the Envelope Messaging (Ad-slogan) and Text must not be obscene, defamatory of any person or group, or deceptive, nor may it advocate unlawful action. The Envelope Messaging (Ad-slogan) must not emulate any form of valid indicia or payment for postage.

## 6 • Machine Settings

---

### **Delete a Text Ad**

1. Press **Options**.
2. Use the **Review ▲ ▼** keys to scroll to "Change Setup?", then press **Enter/yes** to confirm.
3. Use the **Review ▲ ▼** keys to scroll to "Use Text Ad setup?", then press **Enter/yes** to confirm.
4. Use the **Review ▲ ▼** keys to scroll to "Delete a Text Ad?", then press **Enter/yes** to confirm.
5. Use the **Review ▲ ▼** keys to select the Text Ad you want to delete.
6. You will be asked to confirm the deletion by pressing **Yes/Enter** or cancel the deletion by pressing **No**. You can now chose to delete another Text Ad, or press **No** and follow the screen prompts to return to the Home screen.

### **Other Settings**

Within the menus of your DM50 Series you will see some other settings available. These should only be changed under instruction of a representative of your machine supplier.

**Incorrect configuration of some of these settings may cause your DM50 Series to malfunction.**

The settings include:

- Change Location Code
- Remove Funds from Meter
- Change Local Access Number
- Change Data Centre Number
- Change Number You Call From
- Change Modem Initialisation
- Change Distributor Parameters

# Section 7

## Ink Maintenance

### Low Ink Warnings

Your actual ink usage will vary, based on how frequently you use your DM50 Series, the graphic printed and environmental conditions. The DM50 Series display tells you when the ink supply is low or exhausted.

*"Low Ink" and amber LED lit* - Replace the ink cartridge soon. If you don't have a replacement cartridge on hand, you should order one now (see 11 - *Supplies, Options and Accessories*).

---

**IMPORTANT:** Order a replacement ink cartridge as soon as you see the "Low Ink" alert.

---

*"Ink Out" and amber LED blinking once* - Replace the ink cartridge immediately. The ink supply is out; you won't be able to print.

### Replacing the Ink Cartridge

---

**NOTE:** We recommend that you keep a spare ink cartridge on hand at all times.

---

#### IMPORTANT INFORMATION

Pitney Bowes recommends that you only use genuine replacement ink cartridges that are available from Pitney Bowes. If alternative cartridges or refills are obtained, **the ink used must be approved by your Postal Authority.**

1. Press **Options**.
2. Use the **Review ▲ ▼** keys to scroll to "Use ink functions?", then press **Enter/yes** to confirm.
3. Use the **Review ▲ ▼** keys to scroll to "Replace ink cartridge?", then press **Enter/yes** to confirm.

## 7 • Ink Maintenance

---

### Replacing the Ink Cartridge (continued)

4. Open the top cover and locate the ink cartridge (see white circle in illustration.)

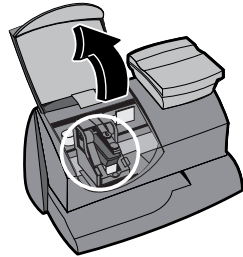

5. Press the top of the ink cartridge latch (on the green "unlock" icon).
6. Tilt the old cartridge towards you and lift out. Discard the old cartridge.

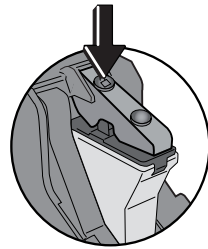

7. Remove the new cartridge from its package and pull off the protective tape.

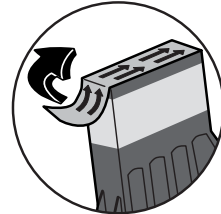

8. Tilt the new cartridge towards you and insert it into the print head. Straighten the cartridge so it is upright.

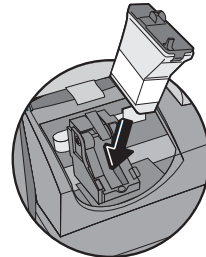

9. Press down on the ink cartridge latch firmly until it locks into place.

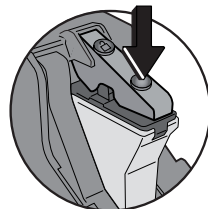

### Replacing the Ink Cartridge (continued)

10. Close the DM50 Series meter cover.  
Press **Enter/yes**.
11. Press **Enter/yes** to confirm the replacement. A print head initialisation occurs which lasts about 2-3 minutes.
12. When prompted, insert an envelope/tape sheet to print a test pattern to confirm print quality.
13. If the test pattern looks good (see figures below), press **Enter/yes**. If it looks poor, press **No** and continue at step 4 in the "Cleaning Printer Nozzle" procedure on the next page.

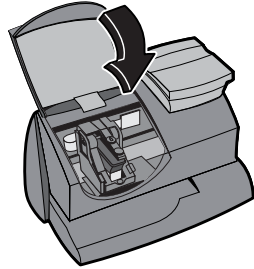

### Printing Test Pattern

Running a print test may help you identify a printing problem.

1. Press **Options**.
2. Use the **Review ▲ ▼** keys to scroll to "Use ink functions?", then press **Enter/yes** to confirm.
3. Use the **Review ▲ ▼** keys to scroll to "Print test pattern?", then press **Enter/yes** to confirm.
4. When prompted, insert an envelope or tape sheet into the DM50 Series. Remove the envelope/tape when prompted.
5. At the "Is test pattern OK" prompt, either press **Enter/yes** if it looks good (you'll return to the Home screen), or press **No** and the DM50 Series will commence a cleaning cycle as described in step 4 of the "Cleaning Printer Nozzle" procedure on the next page.

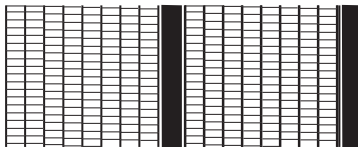

**Good Test Print  
(No Missing Lines)**

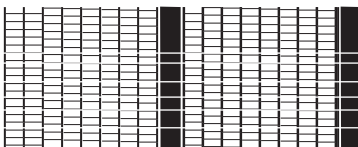

**Poor Test Print  
(Missing Lines)**

## 7 • Ink Maintenance

---

### Cleaning Printer Nozzles

Cleaning the printer nozzles may help you fix a printing problem.

---



**IMPORTANT:** Always ensure that your prints are clear and complete. Poor prints may be rejected by your Postal Authority. If you notice missing lines in the print as shown in the illustration, clean the printer nozzles as described below.



The indicia above is a black and white representation of the approved indicia.

For customers who use the standard Royal Mail product suite, only Red non-fluorescent approved ink should be used in the machine. Customers in the Republic of Ireland should only use Red non-fluorescent ink approved by An Post in the machine.

---

1. Press **Options**.
2. Use the **Review** ▲ ▼ keys to scroll to "Use ink functions?", then press **Enter/yes** to confirm.
3. Use the **Review** ▲ ▼ keys to scroll to "Clean printer nozzles?", then press **Enter/yes** to confirm.
4. A "Preparing ink Please wait..." messages displays as the DM50 Series performs its cleaning.
5. When prompted, insert an envelope or tape sheet into the DM50 Series.
6. At the "Is test pattern OK" prompt...  
If the print is OK, press **Enter/yes**.  
If the print still has missing lines, press **no** and the DM50 Series will perform another cleaning cycle.
7. When finished, follow the prompts to return to the Home screen.

### Replacing the Print Head

---

**IMPORTANT:** This procedure should only be done under the direction of or with the permission of a representative of your machine supplier.

---

1. Press **Options**.
2. Use the **Review ▲ ▼** keys to scroll to "Use ink functions?", then press **Enter/yes** to confirm.
3. Use the **Review ▲ ▼** keys to scroll to "Install new print head?", then press **Enter/yes** to confirm.
4. Open the top cover and locate the print head.
5. Refer to the instructions that came with the new print head to remove the old print head and install the new one.
6. Press **Enter/yes** to confirm the replacement. A print head initialisation occurs which lasts about 2-3 minutes.
7. When prompted, insert an envelope/tape sheet to print a test pattern to confirm print quality.
8. If the test pattern looks good, press **Enter/yes**.  
If the print has missing lines, press **no** and the DM50 Series will perform another cleaning cycle.

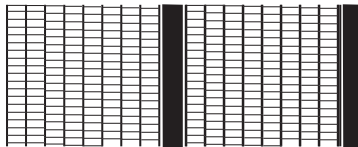

**Good Test Print  
(No Missing Lines)**

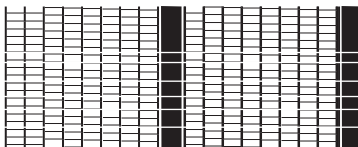

**Poor Test Print  
(Missing Lines)**

9. When the test pattern looks good, press **Enter/yes** to return to the Home screen.

## 7 • Ink Maintenance

---

### Replacing the Ink Tray

---

**IMPORTANT:** This procedure should only be done under the direction of or with the permission of a representative of your machine supplier.

---

1. Press **Options**.
2. Use the **Review ▲ ▼** keys to scroll to "Use ink functions?", then press **Enter/yes** to confirm.
3. Use the **Review ▲ ▼** keys to scroll to "Replace ink waste tray?", then press **Enter/yes** to confirm.
4. Refer to the instructions that came with the new ink tray to remove the old ink tray and install the new one.
5. Press **Enter/yes** when completed. You will automatically return to the Home screen.

# Section 8

## Reports

### Reports

Your DM50 Series allows you to view and print reports for funds usage, postage refills, postage tracked by account, and other valuable data. The printable reports are printed directly from your DM50 Series onto an envelope or tape sheet.

### Funds Report

A funds report allows you to print a record of how much postage has been used and how much is remaining in the DM50 Series.

1. Press **Options**.
2. Use the **Review ▲ ▼** keys to scroll to "Select a report?", then press **Enter/yes** to confirm.
3. Use the **Review ▲ ▼** keys to scroll to "Print funds report?", then press **Enter/yes** to confirm.
4. When prompted, insert a tape sheet or envelope into the DM50 Series.
5. The report is printed and you return back to the reports menu. Follow the prompts to return to the Home screen.

### Refill Summary Report

This report lists the last 5 postage refills.

1. Press **Options**.
2. Use the **Review ▲ ▼** keys to scroll to "Select a report?", then press **Enter/yes** to confirm.
3. Use the **Review ▲ ▼** keys to scroll to "Print refill summary?", then press **Enter/yes** to confirm.
4. When prompted, insert a tape sheet or envelope into the DM50 Series.
5. The report is printed and you return back to the reports menu. Follow the prompts to return to the Home screen.

### Account Reports

If you have the optional accounting feature on your DM50 Series, you can view and print your account totals at any time. You may want to do this before you clear or delete an account, such as at the end of a fiscal year.

1. Press **Options**.
2. Use the **Review ▲ ▼** keys to scroll to "Use Accounting functions?", then press **Enter/yes** to confirm.
3. Use the **Review ▲ ▼** keys to scroll to "Print an Account report?", then press **Enter/yes** to confirm.
4. Select whether you wish to print a single or multiple account report.

*Print Single Report* - Use the **Review ▲ ▼** keys to scroll to the desired account, then press **Enter/yes** to confirm. When prompted, insert an envelope or tape strip.

*Print Multiple Report* - All accounts will print. Insert an envelope or tape strip.

---

**NOTE:** If it is a multi-page report, you will be prompted to insert further envelopes or tape sheets.

---

5. The report is printed. Follow the prompts to return to the Home screen or to print another report.

### Software Version Report

This report lists information about the software within your DM50 Series.

1. Press **Options**.
2. Use the **Review ▲ ▼** keys to scroll to "Select a report?", then press **Enter/yes** to confirm.
3. Use the **Review ▲ ▼** keys to scroll to "Print Software Version report?", then press **Enter/yes** to confirm.
4. When prompted, insert a tape sheet or envelope into the DM50 Series.
5. The report is printed. Follow the prompts to return to the Home screen or to print another report.

### View Software Versions (not printed)

This report lists software information about your DM50 Series meter on the display; it is not printed.

1. Press **Options**.
2. Use the **Review ▲ ▼** keys to scroll to "Select a report?", then press **Enter/yes** to confirm.
3. Use the **Review ▲ ▼** keys to scroll to "View software ver. report?", then press **Enter/yes** to confirm.
4. Use the **Review ▲ ▼** keys to scroll and view the screens of information.
5. Press **Clear/Back** to return back to the reports menu. Follow the prompts to return to the Home screen.



# Section 9

## Departmental Accounting

### Optional Departmental Accounting Feature

When you purchase the optional accounting feature, you can set up your DM50 Series to track postage costs incurred by individuals or departments in your organisation (e.g., Tom, Jane, Sales, A/R, etc.). Your DM50 Series stores the following information for each account:

- An account name up to 14 alphanumeric characters long.
- An account number.
- The item total. This is the total number of pieces of mail charged to an account since it was last cleared.
- The value total. This is the total amount of postage charged to an account since it was last cleared.
- An account password (if you choose to use one).

### Turning the Accounting Feature ON or Off

#### 1. Press **Options**.

*Turning ON Accounting* - Use the **Review ▲ ▼** keys to scroll to "Turn Accounting On?", then press **Enter/yes** to confirm. Follow the prompts for either creating an account (if this is the first time using the feature) or selecting an account (see next page).

*Turning OFF Accounting* - Use the **Review ▲ ▼** keys to scroll to "Use Accounting functions?", then press **Enter/yes** to confirm. Use the **Review ▲ ▼** keys to scroll to "Turn off Accounting?", then press **Enter/yes** to confirm. A confirmation message displays.

- #### 2. Follow the prompts to add another account if turning ON accounting, or press **Clear/Back** to return to the Home screen.

---

#### NOTES:

- You will not be tracking postage by account when this feature is turned off.
  - When accounting is turned on, an account must be selected before you can print postage.
-

## 9 • Departmental Accounting

---

### Creating an Account

You need to create an account before you can use the departmental accounting feature to track postage.

1. Press **Options**.
2. Use the **Review ▲ ▼** keys to scroll to "Use Accounting functions?", then press **Enter/yes** to confirm.
3. Use the **Review ▲ ▼** keys to scroll to "Create an account?", then press **Enter/yes** to confirm.
4. Enter the name of this account. It can be up to 14 alphanumeric characters long. To access alpha characters, repeatedly press the appropriate number key until the desired character displays.  
For more information on entering text, see *Appendix A, How to Enter Text*.
5. Assign a password to this account (if you wish) of 4 digits.
6. Follow the prompts to either add another account or stay in the Accounting menu. Follow the prompts to return to the Home screen.

### Editing an Existing Account

You can edit an account name and password if you wish.

1. Press **Options**.
2. Use the **Review ▲ ▼** keys to scroll to "Use Accounting functions?", then press **Enter/yes** to confirm.
3. Use the **Review ▲ ▼** keys to scroll to "Edit an existing Account?", then press **Enter/yes** to confirm.
4. Use the **Review ▲ ▼** keys to scroll to the account you want to edit, then press **Enter/yes** to confirm.

---

**NOTE:** If a password has been assigned to this account, you will be prompted to enter it now. Key in the 4-digit password if necessary.

---

Depending on how the account is set up, you can:

*Edit Account Name* - follow prompts to change the name.

*Assign a Password to Account* (if none has yet been assigned)  
- follow prompts to assign a 4-digit password.

*Edit Account Password* - follow prompts to change the password.

*Delete Account Password* - follow prompts to delete the password.

5. Follow the prompts to edit another account or return to the Home screen.

### Viewing Account Totals

You can view your account totals any time using this option.

1. Press **Options**.
2. Use the **Review ▲ ▼** keys to scroll to "Use Accounting functions?", then press **Enter/yes** to confirm.
3. Use the **Review ▲ ▼** keys to scroll to "View Account postage and pieces?", then press **Enter/yes** to confirm.
4. Use the **Review ▲ ▼** keys to scroll to the desired account. The postage and number of pieces for this account displays.
5. Press **Clear/Back** and follow the prompts to return to the Home screen.

## 9 • Departmental Accounting

---

### Clearing All or Some of the Accounts

You can clear the postage totals in an account when necessary (for example, at the end of a fiscal year).

---

**IMPORTANT:** Make sure you really want to clear an account. Once you do, the account information is gone forever. We suggest you print an accounting report first (see *section 8, Reports*) before clearing.

---

1. Press **Options**.
2. Use the **Review ▲ ▼** keys to scroll to "Use Accounting functions?", then press **Enter/yes** to confirm.
3. Use the **Review ▲ ▼** keys to scroll to "Clear Account value and pieces", then press **Enter/yes** to confirm.
4. Select All or One account to clear.

*Clearing All Accounts* - Confirm clearing all when prompted.

*Clearing One Account* - Use the **Review ▲ ▼** keys to scroll and select the account to clear. Confirm clearing when prompted.

---

#### NOTES:

If a password has been assigned to an account, you will be prompted to enter it now. Key in the 4-digit password if necessary.

If passwords are being used with your accounts, you will not see the option to 'Clear All Accounts'. You must clear each account individually.

---

5. Follow the prompts to clear another account or return to the Accounting menu. Follow the prompts to return to the Home screen.

### Deleting an Account

You can delete an account when necessary.

---

**IMPORTANT:** Make sure you really want to delete an account. Once you do, the account information is gone forever. We suggest you print an accounting report first (see *section 8, Reports*) before deleting.

---

1. Press **Options**.
2. Use the **Review ▲ ▼** keys to scroll to "Use Accounting functions?", then press **Enter/yes** to confirm.
3. Use the **Review ▲ ▼** keys to scroll to "Delete an account?", then press **Enter/yes** to confirm.
4. Use the **Review ▲ ▼** keys to scroll to the account you want to delete, then press **Enter/yes** to confirm.

---

**NOTE:** If a password has been assigned to this account, you will be prompted to enter it now. Key in the 4-digit password if necessary.

---

5. Confirm deleting when prompted.
6. Follow the prompts to delete another account or return to the Accounting menu. Follow the prompts to return to the Home screen.

## **9 • Departmental Accounting**

---

# Section 10

## Troubleshooting

### Getting Help

There may be times when you need help to solve a problem, or you may want more information about how your DM50 Series works. Please read the troubleshooting information in this section first. In many cases, it can help you resolve the problem.

If you need to contact us, please have the following information at hand:

- Product Model: DM50 Series.
- Serial number: See the back of the DM50 Series.
- Nature of problem: What happens and when does it happen? Did the DM50 Series display an error message?
- The steps you've already taken to solve the problem and the results.

Details of how to contact your machine supplier will be either in a separate document supplied with your DM50 Series, on the back cover of this guide, or on a sticker applied to your DM50 Series.

#### **IMPORTANT INFORMATION**

The DM50 Series has been approved for use in the Republic of Ireland by An Post and in the UK by Royal Mail. Under the terms of your licence you are not allowed to tamper with or modify the machine in any way.

# 10 • Troubleshooting

## Error Messages

From time-to-time your DM50 Series may display an alert or error message. An alert tells you that something needs attention; an error message usually tells you about a DM50 Series condition you can fix.

Message	Description	Action
<i>Account Balance Low</i>	Refill amount exceeds funds available or credit limit.	Perform Refill procedures for smaller amount, make an advance payment or call your machine supplier for credit.
<i>Cannot Reach Data Centre</i>	Trouble getting a connection to the Data Centre.	Try connecting again in a few minutes. Check the Data Centre phone number under Setup.
<i>Connection Lost</i>	Connection made but lost before transaction completed.	Press <b>Clear/Back</b> ; try again in a few minutes. If problem persists call your machine supplier.
<i>Inspection Due (ROI Only)</i>  <i>Inspection Required (ROI Only)</i>	This message displays if a refill has not been performed within a specific number of days.  After a second defined period, postage cannot be printed until a Refill/Inspection is carried out.  In the ROI, Inspection Due appears after 60 days, and Inspection Required appears after 90 days.	Perform a Refill procedure. If you do not want to add funds at this time, simply check your account balance.
<i>Insufficient Funds</i>	Insufficient funds in your DM50 Series. Postage amount selected exceeds maximum funds available in meter.	Select a lower postage amount. Perform a funds refill to add funds to the DM50 Series.
<i>Refill Too High</i>	Refill amount entered is more than the maximum DM50 Series will allow.	Press <b>Clear/Back</b> . Repeat refill procedure will a smaller refill amount.
<i>Data Capture Required (UK Only)</i>	An audit of your meter is required every 30 days. This message will display if an you have not connected to the Data Centre in the last 30 days and an audit is due. You have 5 days grace to complete the connection.	Connect to the Data Centre to allow your meter to automatically upload information to the Postal Authority.

If you encounter an error that has no accompanying message (such as "1103", "2215", etc.), press **Clear/Back**. If nothing happens in 5 seconds, turn off machine; wait 15 seconds, and then turn on machine. If problem persists, call your machine supplier.

## Nothing Displays

1. The DM50 Series meter may be in sleep mode. Press any key to wake it.
2. Is power cord plugged into both the DM50 Series meter and the wall outlet? Make sure the power cord is not connected to a switched wall outlet with the outlet turned off.
3. Try unplugging the power cord, wait 15 seconds, and reconnect the cord.

## Printing is Incomplete, Streaked, or Poor Quality



**IMPORTANT:** Always ensure that your prints are clear and complete. Poor prints may be rejected by your Postal Authority. If you notice missing lines in the print as shown in the illustration, clean the printer nozzles as described on page 7-4 of this guide.



The indicia above is a black and white representation of the approved indicia.

For customers who use the standard Royal Mail product suite, only Red non-fluorescent approved ink should be used in the machine. Customers in the Republic of Ireland should only use Red non-fluorescent ink approved by An Post in the machine.

If printer maintenance fails to correct the problem, call your machine supplier. You may have to replace the printhead.

### Display is Difficult to Read

You can adjust the LCD display contrast if necessary (see page 6-2).

### Problems Dialling Out

#### *Problem with phone line connected to DM50 Series*

Make sure you've connected your DM50 Series to a working analogue phone line (the same type you connect your fax to). Also make sure the phone line connectors are firmly seated.

#### *Incorrect DM50 Series settings*

One or more of the DM50 Series settings may be set up wrong. Go to *Section 6 - Machine Settings* and check the following:

- Does your phone system require you to dial a prefix number to get an outside phone line? Make sure to include this in the setup if needed.
- Is the dial method correct? You have to tell the DM50 Series if your phone uses a pulse or tone for dialling. (Almost all telephone systems now use tone dialling).

#### *Problem with PC Meter Connect™*

Make sure that the USB cable is connected between the DM50 and your PC. Also check that your PC is able to connect to the internet.

### Accidentally Printing the Wrong Postage

Once you have printed a meter stamp, the postage funds have been “used up” by the DM50 Series, even if the printing is illegible. That’s why it is so important to make sure the correct value is shown on the machine before inserting the envelope or tape sheet, and that you do not let the ink level get too low. We recommend you always keep a spare ink cartridge on hand just for this reason.

To help prevent you from accidentally printing a postage value that’s more than you need, you can have the DM50 Series warn you when you manually key in a postage value that is higher than a maximum amount that you specify. This setting is known as the high value warning (see *Section 6 - Machine Settings* to set this option).

---

**NOTE:** This warning does not function if the internal rating feature is being used to calculate postage.

---

# Section 11

## Supplies and Options

### How to Order

All supplies, accessories and options are available from your machine supplier.

Contact details are given on a separate document supplied with your DM50 Series, on the rear page of this guide and/or on a 'sticker' applied to the machine.

### Supplies

Your DM50 Series requires certain supplies to function properly. These include:

- Ink Cartridges
- Tape Sheets
- Sealing Solution (to seal envelope flaps after processing)

#### IMPORTANT INFORMATION

Pitney Bowes recommends that you only use genuine replacement ink cartridges that are available from Pitney Bowes. If alternative cartridges or refills are obtained, **the ink used must be approved by your Postal Authority.**

### Options

A number of flexible options are available so you can tailor your DM50 Series to meet your exact needs today, and expand it as your business grows tomorrow. Contact your machine supplier who will advise you about the options available on your model.

#### *Postal Advertisements (Ads)*

Ads give your mail a professional appearance and can turn your mailings into a powerful promotional tool. You can purchase additional ads if your needs require it.

Optional ads are conveniently loaded into your machine over the telephone line via software downloads.

#### *Departmental Accounting*

The accounting feature tracks postage costs for departmental accounts. See *Chapter 9, Departmental Accounting* for details.

#### *Scale/Internal Rating*

The optional scale allows you to accurately weigh mail and packages and, in conjunction with the internal rating feature, calculate the correct postage.

#### *Extension Cable for Scale*

The extension cable allows you to position the scale away from the DM50 Series should you prefer it not to be situated in the standard position.

# Appendix A

## How to Enter Text

### When is Text Entry Used?

Text is entered for these functions:

- Entering a Text Ad (optional feature)
- Naming an Account (with optional Departmental Accounting)
- International mail (selecting a country)

### How is Text Entry Done?

Text entry is done via the numeric keypad in a fashion similar to current mobile phone text entry. Each key, 2 to 9, has three or four letters displayed above it.

There is no dedicated key to switch between alpha and numeric mode. On those screens (and only those screens) where either an alpha or numeric character may be entered (e.g. account names), press a numeric key to cycle through the possibilities for that key. For example, pressing the "2" numeric key cycles through "2" - "A" - "B" - "C".

Extended character sets are provided for foreign markets on a country-by-country basis. In these cases, a numeric key may need to be pressed several times to cycle through the complete character set associated with that key.

### ***Account Names, Text Ads***

For Account names and Text Ads, the first letter of the first word automatically defaults to upper case.

If you wish to enter two consecutive alpha characters that are located on the same numeric key (such as "de"), you must wait for the cursor to automatically move right to the second character's position before entering the second character. There is about a one second delay following an alpha entry before the cursor moves one position to the right.

## Appendix A • How to Enter Text

---

### Special Characters

Special characters are accessed by repeatedly pressing the “1” key. Special characters include:

Symbol	Name
,	Comma
&	Ampersand
*	Asterisk
.	Period
:	Colon
\$	Currency symbol
-	Minus sign (dash)
?	Question mark
/	Forward slash
\	Backward slash
(	Open parenthesis
)	Close parenthesis
!	Exclamation point
@	“at” sign
+	Plus sign
#	Hash mark
%	Percentage
^	Upper carrot
=	Equal sign

The 0 (zero) key on the keypad functions as the space key.

The decimal point key also functions as the Shift key. On any screen that accepts alpha characters, this key toggles between “all upper case letters” and “all lower case letters.”

# Appendix B

## Glossary

**Account** — A department (e.g., “Human Resources”) to which postage is charged when the optional Departmental Accounting feature is purchased. You can assign a unique name to each account. The DM50 Series stores the total postage used and the number of mail pieces processed for each account.

**Ascending Register (Used)** — The total amount of postage used since the machine was placed in service.

**Batch Register** — A part of the DM50 Series meter’s memory that stores the total postage spent and the number of pieces of mail processed. Your DM50 Series meter stores this information in memory for each account. You can clear the contents of the batch register if you want.

**Default** — A value or setting the DM50 Series meter automatically uses unless you change it. As delivered, your DM50 Series meter has factory-set defaults or “normal” settings. You may change these if you wish.

**Descending Register (Unused)** — The total amount of postage left in your DM50 Series which is available to use.

**Digital Impression** — The imprint produced by the DM50 Series This may include:

- The postage amount and Postal Authority official 'mark'.
- Envelope Messaging. This is an optional part of the DM50 Series meter stamp that lets you convey your own special message to the mail recipient. Text Ads are a purchasable option.
- The Date .
- The DM50 Series meter’s Serial Number.
- Information for Postal Authority use.

**Envelope Messaging** — An additional message that appears next to the DM50 Series meter’s digital meter impression. You can choose from an array of standard and custom Graphic Ads or create your own Text Ads if your system has the Text Ad option. See *Section 11 - Supplies and Options* for ordering.

## Appendix B • Glossary

---

**Home Screen** — The DM50 Series display that shows your current selections. It indicates that you're ready to print postage.

**Inspection** — The process of examining the postage usage through the DM50 Series to assure accurate postal funds accounting. Your DM50 Series is subject to remote inspection whenever you add postage to it. To do an inspection, simply connect to the Data Centre to add postage or check your account balance as explained in *Section 5 - Adding Postage/Connecting to Data Centre*.

**IntelliLink®** — A technology that allows you to download postage meter features, postal rates, and postage meter software updates via a telephone link.

**Lock Code** — A four-digit code that serves as a user password. It prevents unauthorised DM50 Series use.

**Modem** — The part within the DM50 Series that dials into the Data Centre and transfers information over the phone line.

**PC Meter Connect™** — Pitney Bowes software for your PC that allows your DM50 Series to access the Data Centre using your PC's internet connection.

**Postage By Phone®** — A service that allows you to buy postage and check account status over the phone. It also permits convenient postal inspection by phone.

**Preset** — A DM50 Series setting you can call up at the push of a button. The preset can hold a postage amount, account, Envelope Messaging, inscription and class of service.

**Serial Number** — The serial number found on the rear of the DM50 Series.

**Sleep Mode** — An energy-saving feature of your DM50 Series that clears the display after a certain period of idle time. Pressing any key wakes up the DM50 Series.

**Tape/Label Sheets** — A sheet of self-adhering paper which you print postage on and apply to a piece of mail or package that is too big to be processed through the DM50 Series.





Elizabeth Way,  
Harlow, Essex, CM19 5BD, UK  
[www.pitneybowes.co.uk](http://www.pitneybowes.co.uk)

PB Form SDC667C RevD (01-12)

© Pitney Bowes Limited, 2012

We have made every reasonable effort to assure the accuracy and usefulness of this guide, however we cannot assume responsibility for errors or omissions or liability for the misuse or misapplication of our products.

V9.02.00



\* S D C 6 6 7 C \*